

HIGH PRODUCTIVITY • ROBUSTNESS • PRECISION • TECHNOLOGY

VERTICAL MACHINING CENTERS - 5-AXIS / 5-FACE

# ROMI DCM 620 SERIES

NEW GENERATION



[www.romi.com](http://www.romi.com)











MUCH MORE  
PRODUCTIVITY  
AND PROFITABILITY  
FOR YOUR  
BUSINESS!

*In the constant transformation of industrial processes, it is crucial to have **competitive advantages that make your products superior.***

*In this context, the integration of new technologies into your production process, particularly through **modern, fast, and precise machine tools, enhances production performance.***

*You achieve higher quality, productivity, efficiency, and, most importantly, higher profits than what you have already achieved in your business!*

With more than 90 years of history and global presence, we have preserved the values that have made our products recognized worldwide. **We offer the most cost-effective machine tools on the market.** Our commitment to the constant development of new solutions and dedication to innovation, results in robust, highly technological and quality machine tools.

**We guarantee full support at all stages of purchase** through our sales and sales engineering teams, customer training, specialized technical assistance and spare parts.

**Owning a Romi machine tool assures that you have state of the art equipment** combined with a reputation of value, providing a high resale value in the future.

At Romi, you get a complete solution, much more than just a piece of equipment: **you have the security and confidence of counting on the manufacturer at all times, whenever you need it.** Count on us to find a solution that fits your needs. **Our main goal is to make your business even more productive and profitable.**



Ultra Clean room

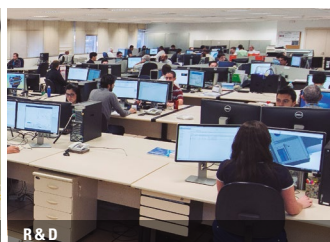

R & D



Flexible Manufacturing System (FMS)



Specialized technical assistance



Training



Spare parts

# ROMI DCM 620 SERIES

NEW GENERATION

High productivity with robustness, precision, and technology







The **ROMI DCM 620 Series - New Generation** features advanced 5-axis / 5-face vertical machining centers designed for machining simple and complex geometries at high speeds. With a 5-axis / 5-face configuration, complex parts can be machined in a single setup, significantly reducing machining time with efficiency, precision, and productivity.



### ROMI DCM 620-5F (5 FACES)

<b>Headstock</b>	10,000 or 15,000 rpm
<b>Spindle taper</b>	ISO 40
<b>Motor</b> (regime S6-40% - 10 min)	20 hp / 15 kW (10,000rpm) 22 hp / 16,5 kW (15,000rpm)
<b>Automatic tool changer</b>	30 tools capacity
<b>Rotary table</b>	600 x 600 mm (23.6 x 23.6 in)
<b>CNC</b>	Siemens Sinumerik 828D

### ROMI DCM 620-5X (5 AXIS)

<b>Headstock</b>	15,000 rpm
<b>Spindle taper</b>	ISO 40
<b>Motor</b> (regime S6-40% - 10 min)	22 hp / 16,5 kW
<b>Automatic tool changer</b>	30 tools capacity
<b>Rotary table</b>	600 x 600 mm (23.6 x 23.6 in)
<b>CNC</b>	Siemens Sinumerik One





# STRUCTURE

## ROBUSTNESS AND TECHNOLOGY

The quality of ROMI machines' manufacturing processes ensures reliability and operational effectiveness. All machines are inspected with a laser system for positioning and repeatability measurements. Axis alignment verification is performed using a Ball Bar system, ensuring perfect interpolation of axes B and C.

Designed in a 3D CAD system, the machines in the ROMI DCM line have their entire structure dimensioned by finite element analysis (FEA) software, resulting in structures suitable for each machine.





## Z-AXIS THERMAL COMPENSATION

Through sensors installed in strategic locations of the equipment, mathematical algorithms correct the position of the Y and Z axes in real-time. This ensures stable dimensional results, even during long periods of work.

**Excellent thermal insulation design,** minimizing displacements caused by heating, offering high positioning accuracy of the spindle and long life to the assembly.

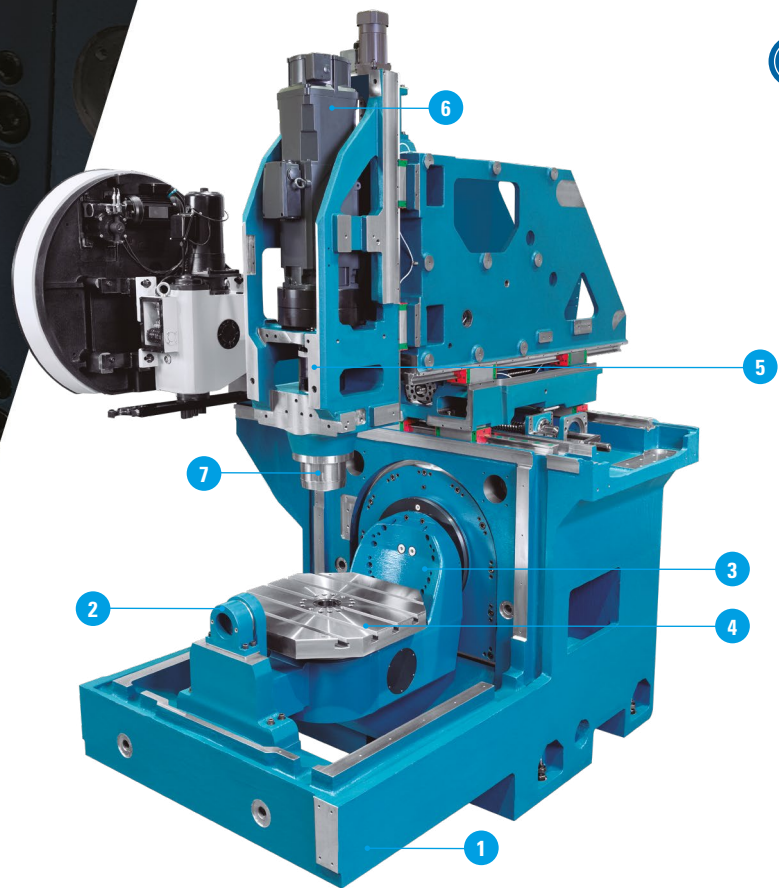

1

**RIGID AND ROBUST MONOBLOCK BASE:** Supports the table assembly, consisting of axes B and C, as well as the cross slide and spindle assembly. The X, Y, and Z axes are equipped with roller linear guides, offering high rigidity, stability, precise positioning, and high-quality surface finish for machining processes, providing maximum efficiency and productivity to the user.

2

**SUPPORT BEARING:** Ensures total rigidity of the table during operations with high loads.

3

**INCLINED AXIS TABLE (Axis B):** Supports the rotary axis and allows positioning from +110° to -50°.

4

**ROTARY AXIS TABLE (Axis C):** Enables part positioning in any position with a 360° range.

5

**CROSS SLIDE:** Robust structure that supports the entire spindle assembly. Equipped with linear roller guides, it is supported by shoes with a locking system that provides high rigidity and allows high-speed movements.

6

**MAIN MOTOR:** Directly coupled to the spindle cartridge, offering high efficiency in torque and power transmission.

7

**SPINDLE CARTRIDGE:** Directly coupled to the main motor (direct drive) with high efficiency in power and torque transmission. It has the advantage of low noise, eliminating gaps and vibrations, it provides a significant improvement compared to pulley and belt systems. It offers a maximum rotation speed of 10,000 (\*) or 15,000 rpm, ensuring excellent performance under severe cutting conditions at full power.

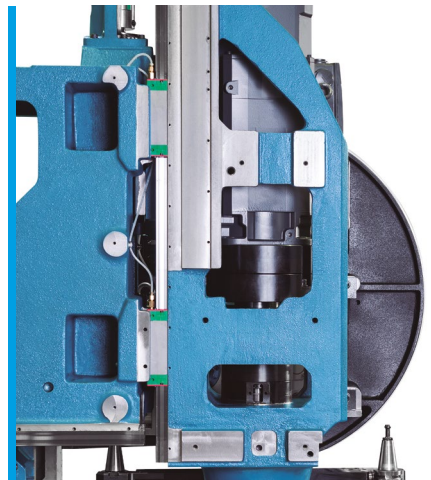

(\*) Only for ROMI DCM 620 - 5F





# KINEMATIC MEASUREMENT SOFTWARE

Through the kinematic measurement software, it is possible to identify and adjust the correct rotational centres of the B and C axes in relation to the linear X, Y, and Z axes. This ensures that the machine is calibrated with minimized kinematic errors.

The measurement cycle is provided with the machine and is simple and quick to execute. The kinematic compensation is specific and dedicated to each machine produced, performed during commissioning in the production process at Romi.

For kinematic measurement routines before machining parts with tighter tolerances, the optional "calibration sphere" and "part measurement/inspection" need to be purchased.



## INCLINED AXIS (AXIS B) AND ROTARY AXIS (AXIS C)

**ROMI DCM 620-5F** - The NC rotary/inclined table offers high rigidity, ensuring precision in 5-axis machining with angular positioning, resulting in precise positioning of parts.

**ROMI DCM 620-5X** - The NC rotary/inclined table offers high rigidity. It is equipped with angular encoders, ensuring precision in simultaneous 5-axis machining with angular positioning, resulting in highly precise complex parts.

## ANGULAR ENCODER (AXES B AND C)

This second measurement system provides the machine with high precision and repeatability in the positioning of the rotary axes, required for machining complex and precision parts. The encoder directly reads the position of the axis it is installed on and sends signals relative to the angular position of the axis to the CNC. The position reading is direct and real, without any interference from the table transmission system errors.

### Characteristics of Axes B and C:

- Inclination range of Axis B:  $+110^{\circ}$  to  $-50^{\circ}$
- Rotation range of Axis C:  $360^{\circ}$
- Axes B and C are driven by independent servo motors.
- Maximum permissible weight on the table for Axes B and C: 500kgf
- Maximum rotation speed of Axes B and C: 25 rpm
- Clamping torque: Axis B = 4,500 N.m  
Axis C = 2,500 N.m

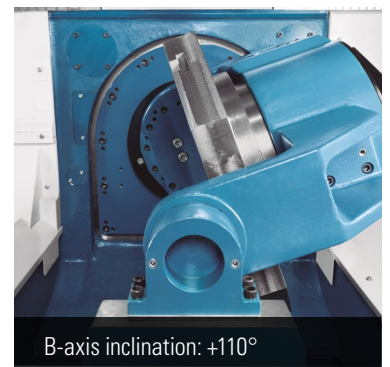
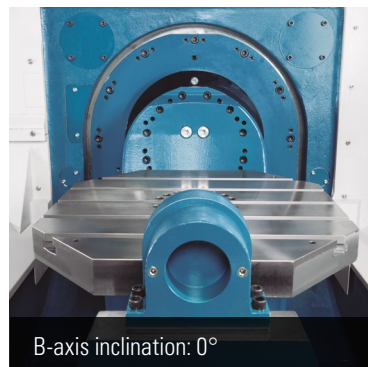
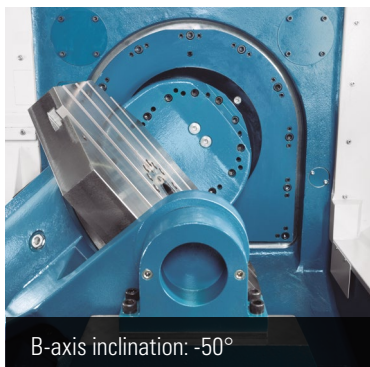



# HEADSTOCK

## HIGH PERFORMANCE AND PRECISION

Direct drive spindle - directly coupled to the headstock cartridge. The direct drive system is highly efficient, allowing for high performance in acceleration and deceleration. It offers low noise, eliminates backlash, and dampens vibrations. It also provides high quality in operations with rigid tapping.

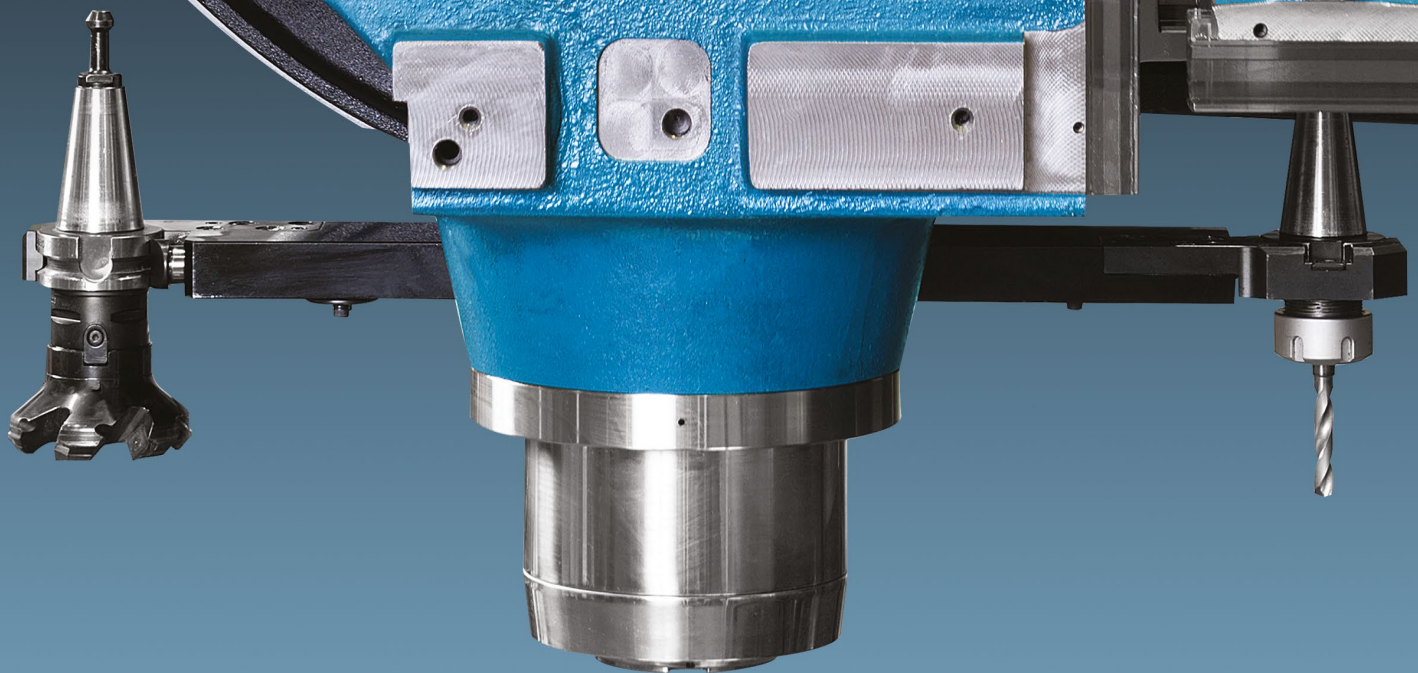





### SPINDLE WITH AIR-OIL LUBRICATION (15,000 rpm version)\*

The system consists of a dedicated oil unit and an air treatment unit. Through separate pipelines, oil and air enter a mixing valve, and this lubricating mixture is directed to the spindle bearings.

In addition to serving as a conduit for the oil, the air also assists in cooling the bearings, resulting in lower heat generation and improved machining performance.

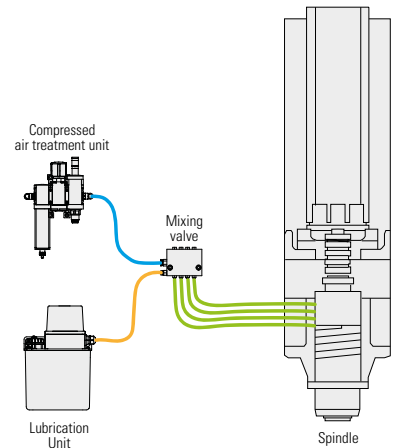

### Headstock cooling system (15,000 rpm version)\*\*

The headstock and the flange seat between the motor and the cartridge are cooled by a fluid recirculation system specifically designed for the headstock, which ensures thermal and geometric stability of the assembly. The headstock housing has a chamber that surrounds the cartridge housing for the circulation of the cooling liquid.

The cooling system consists of a cooling unit (air-fluid heat exchanger), which circulates the cooling liquid in the headstock housing, removing all the heat generated by the spindle bearings. The system reduces the temperature variation between the headstock and the environment, where the headstock temperature remains very close to the ambient temperature. It brings the great benefit of minimizing possible thermal distortions of the housing, ensuring the perfect alignment of the spindle centerline in machining operations that require high Z-axis positioning accuracy.

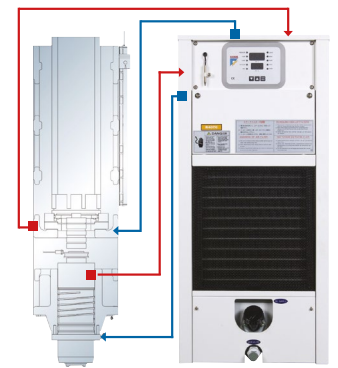

### Sag Compensation - Position and inclination compensation

For machines where the mass of the structural assembly and inclined axes are moved, there is an increase in positional and angular errors, directly impacting the machined part. To minimize these errors, position and inclination compensation is a feature that results in improvements in the machine's geometric performance.

This compensation is based on a "zero point" reference measurement and error measurements along the travel, resulting in a compensation table. During machining, the moving axis is compensated by interpolating its movement with the compensation table.

The compensation is specific and dedicated to each machine produced, performed during commissioning in the production process at Romi.

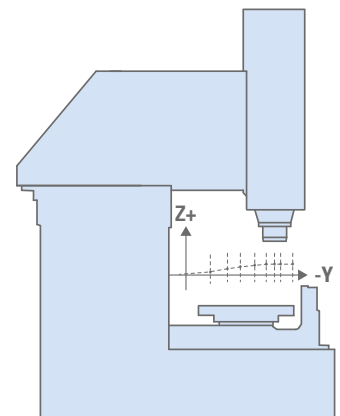

(\*) Air-oil lubrication is applied only in the 15,000 rpm version. For the 10,000 rpm version, the bearing is lubricated with permanent grease.

(\*\*) 10,000 rpm version - headstock cooling system is optional.





# AUTOMATIC TOOL CHANGER

System with automatic arm ATC, which offers speed and reliability in tool changing. It has a magazine for BT/BBT 40 type tool holders, with a capacity of up to 30 tools.



## BT / DIN / CAT Tool holder (\*) – dimensions in mm

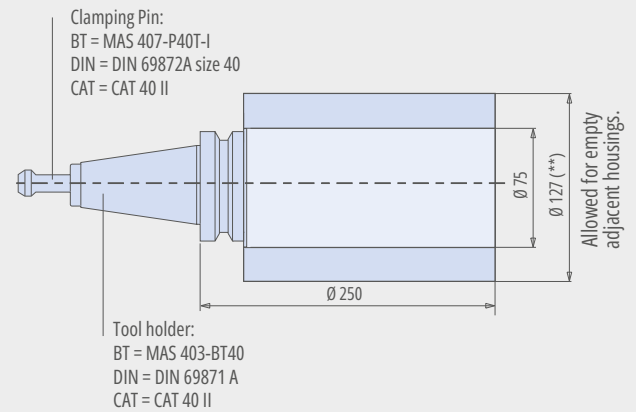

(\*) CAT tool changer is optional

(\*\*) For rotations above 10,000 rpm:  $\varnothing$  117mm

(\*\*\*) For machines with through-spindle coolant system, the tool holders and clamping pins must have a passage hole for coolant.

For rotations above 10,000 rpm, it is recommended to use BBT chucks. Regardless of the rotation, all tools should be balanced to G2.5.

## LASER TOOL BREAKAGE DETECTOR (Optional)

This system performs contactless tool breakage detection using a laser beam, obtaining tool status identification during the machining process.

Measurements can be made during cutting processes and between tool changes, enabling high-speed (rotational) detection.

It also allows for automatic replacement of a worn-out tool with an equivalent tool available in the tool changer, thereby avoiding scrap parts when combined with the tool life management system.

## TOOL PRESETTER (Optional)

**Laser Option (\*) / Optical Option - fixed on the base (\*) / Optical Option - fixed on the side of the table**

Tool setup through automatic inspection of diameter and length, with automatic offset compensation in the CNC tool offset page, significantly reducing machine setup time (reducing machine downtime). Tool breakage detection during machining processes.

It also enables automatic replacement of a worn-out tool with an equivalent tool available in the tool changer, thereby avoiding scrap parts when combined with the tool life management system. Elimination of errors from manually entering tool data in the CNC tool offset page.

For the laser pre-setter, due to the non-contact measurement using a laser beam, the measurements have improved measurement cycle time and greater robustness in the machining environment.

(\*) Reduces working envelope. Consult layout.





# STABILITY AND PRECISION





## ROLLER LINEAR GUIDES

Offer high load capacity, high rigidity, and stability even in severe machining operations. They allow for rapid, precise displacement and high acceleration due to the low friction coefficient between rails and shoes.

### Advantages of linear guides:

- High rigidity, high load capacity, long durability;
- Rapid positioning of axes, minimizing idle times, increasing productivity;
- Low lubricating oil consumption;
- Maintenance convenience.

## OPTICAL SCALE (Optional)

This option provides the machine with high precision and repeatability in positioning of linear axes, required in the machining processes of complex and precision parts. The scale directly reads the position of the axis it is installed on and sends position-related signals to the CNC. The position reading is direct and real, so there is no interference from any ball screw step error caused by heating.

## CALIBRATION SPHERE (Optional)

It is a cost-effective solution for verifying the performance in alignment and positioning of rotary axes. In just a few minutes, the machine can identify and notify deficient alignments and geometries that can cause non-conformity of parts.

## PROBE AND OPTICAL RECEIVER (Optional)

The use of this system allows the user to reduce part setup times on the machine, as well as inspection processes, leaving more time for the machine to effectively machine parts.

After measuring a workpiece or fixture, the machine itself performs self-alignment, as the machining program references can be rotated based on the positioning information read by the probe and provided to the CNC.

It also enables in-process inspection to monitor dimensional and positional accuracy of the workpiece, making automatic corrections if necessary.







# CHIP MANAGEMENT

## COMPLETE REMOVAL OF MACHINING RESIDUES

The steep inclination of the base and trays provides chip flow to the chip conveyor belt.

### Swarf Conveyors (mandatory optional selection)

Model	Swarf Type	Material				
		Steel	Aluminum	Non-ferrous (bronze and brass)	Cast Iron	
TCE (metal articulated conveyor)	 Spiral or long	 Fine and short				
TCA (drag conveyor)	X	●	○	○	○	○
TCL (floating light swarfs)	○	○	●	○	○	X

● Recommended    ○ Partially recommended    X Not recommended

**TCA:** Chips with dimensions smaller than 0.5 mm may contaminate the tank and require frequent cleaning / Clusters of chips or chips with dimensions greater than 50 mm may jam the conveyor.

**TCE:** Short chips with dimensions smaller than 5 mm may contaminate the tank and require frequent cleaning.

**TCL:** Chips with dimensions smaller than 0.5 mm can contaminate the tank and require frequent cleaning.



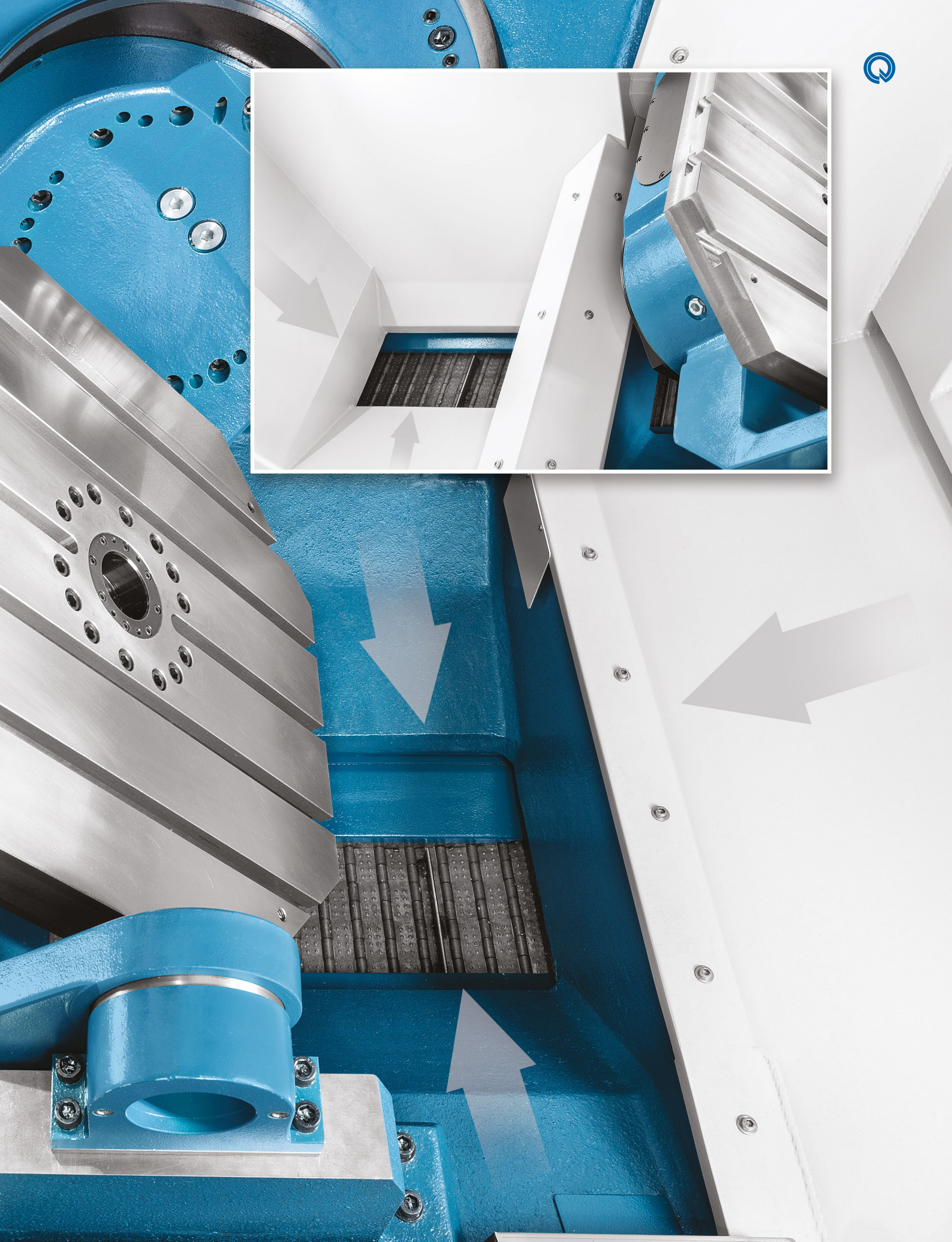
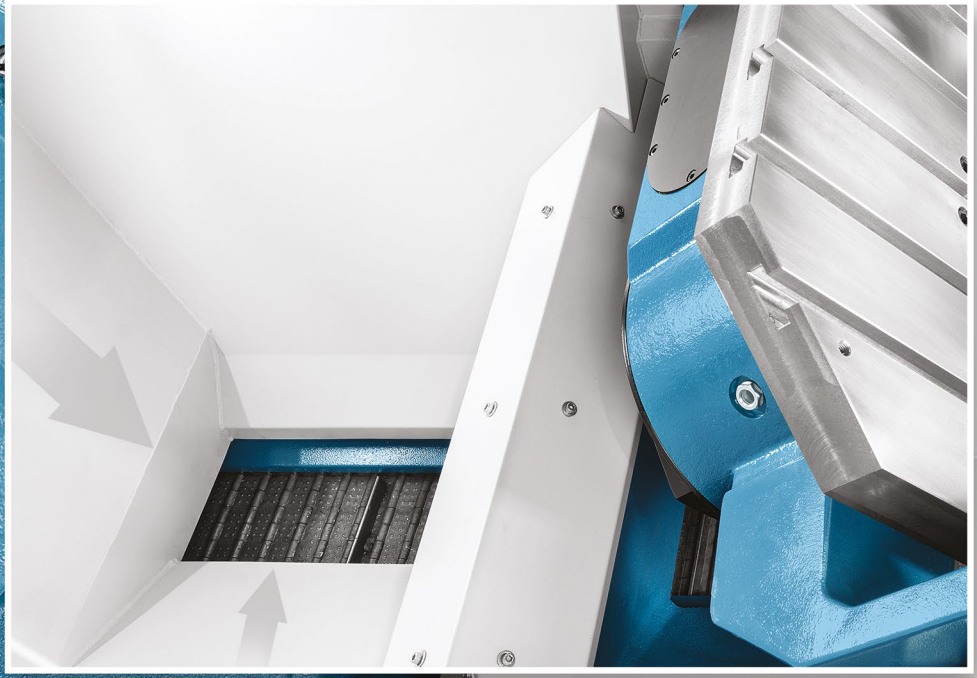



Technical Specifications		ROMI DCM 620-5F	ROMI DCM 620-5X
<b>Vertical Headstock</b>			
Spindle taper	ISO	40	40
Speed ranges (version 10.000 rpm)	rpm	10 to 10,000	-
Speed ranges (version 15.000 rpm)	rpm	15 to 15,000	15 to 15,000
<b>Feeds</b>			
Rapid traverse (X / Y / Z axes)	m/min (in/min)	36 (1,417)	36 (1,417)
Max. Programmable cutting feed	m/min (in/min)	36 (1,417)	36 (1,417)
Maximum rotation (B and C axes)	rpm	25	25
<b>Travels</b>			
X axis travel	mm (in)	620 (24.4)	620 (24.4)
Y axis travel	mm (in)	520 (20.47)	520 (20.47)
Z axis travel	mm (in)	470 (18.5)	470 (18.5)
Distance between spindle and table	mm (in)	150 ~ 620 (5.9 ~ 24.4)	150 ~ 620 (5.9 ~ 24.4)
Rotation angle - B axis	degrees	+110° ~ -50°	+110° ~ -50°
Rotation angle - C axis	degrees	360°	360°
<b>Rotary table</b>			
Table surface	mm (in)	600 x 600 (23.6 x 23.6)	600 x 600 (23.6 x 23.6)
Number of Slots ("T" slots)	mm (in)	5 (0.19)	5 (0.19)
T-slot width x distance	mm (in)	18 x 100 (0.7 x 3.93)	18 x 100 (0.7 x 3.93)
Central guide hole	mm (in)	Ø 60 H7 (Ø 2.36 H7)	Ø 60 H7 (Ø 2.36 H7)
Max. piece dimension on table (*)	mm (in)	Ø675 x 430 height or Ø520 x 330 height (Ø26.6 x 16.9 height or Ø20.5 x 13 height)	Ø675 x 430 height or Ø520 x 330 height (Ø26.6 x 16.9 height or Ø20.5 x 13 height)
Allowed weight (evenly distributed)	kg	500	500
<b>Automatic tool changer</b>			
Tool capacity		30	30
Tool max. diameter	mm (in)	75 (2.95)	75 (2.95)
Max. tool diameter when adjacent stations are empty	mm (in)	Up to 10,000 rpm = 127 (5) Above 10,000 rpm = 117 (4.6)	Up to 10,000 rpm = 127 (5) Above 10,000 rpm = 117 (4.6)
Max. tool length	mm (in)	250 (9.8)	250 (9.8)
Max. tool weight	kg	7	7
Max. Weight on magazine	kg	150	150
Tool holdertype	type	BT or DIN / CAT (**)	BT or DIN / CAT (**)
<b>Power (10.000 rpm)</b>			
Motor principal ca (regime S6 - 40% - 10 min.)	hp/kW	20 / 15	-
Main motor AC (continuous rating)	hp/kW	13.5 / 10	-
Total installed power	kVA	50	-
<b>Power (15.000 rpm)</b>			
Main motor AC (rating S6 - 40% - 10 min.)	hp/kW	22 / 16.5	22 / 16.5
Main motor AC (continuous rating)	hp/kW	15 / 11	15 / 11
Total installed power	kVA	50	50
<b>Dimensions and weight (***)</b>			
Height (max. travel)	mm (in)	2,963 (116.6)	-
Floor space required (front x side)	mm (in)	Version 10,000rpm = 3,559 x 3,642 (140.1 x 143.4) Version 15,000rpm = 3,559 x 4,476 (140.1 x 176)	-
Net weight	kg (lbs)	9,100 (20,062)	-

(\*) See options in the work layout (page 21)

(\*\*) Optional

(\*\*\*) Machine without options





## Standard Equipment

- Headstock with ISO-40 spindle taper, BT/BBT-40 or DIN-40 tool interface
- Rapid traverse on X, Y, and Z axes of 36000 mm/min
- Siemens Sinumerik 828D CNC with 15.6" color LCD monitor (ROMI DCM 620-5F)
- Siemens Sinumerik One CNC with 24" color LCD monitor (ROMI DCM 620-5X)
- Chip and splash guard
- Thermal compensation for Z-axis
- X-axis longitudinal travel of 620 mm, Y-axis transversal travel of 520 mm, and Z-axis vertical travel of 470 mm
- Complete ROMI product documentation on a USB drive
- B-axis with positioning from +110° to -50°
- C-axis with full 360° positioning
- Angular encoder for B-axis and C-axis
- Spindle speed range of 10 to 10,000 rpm, with maximum torque of 82 Nm (S6 40% duty cycle) (ROMI DCM 620-5F)
- Spindle speed range of 15 to 15,000 rpm, with maximum torque of 82 Nm (S6 40% duty cycle)
- 20 hp (15 kW) AC main motor in S6-40% duty cycle - 10 min (10,000 rpm version)
- 22 hp (16.5 kW) AC main motor in S6-40% duty cycle - 10 min (15,000 rpm version)
- Roller-type linear guides on X, Y, and Z axes
- Interface for tool preset system with optical sensor and/or part measurement/inspection system
- "Romi Connect" system for communication between the machine and Romi
- Electrical installation available for 380 Vac 50/60 Hz voltage/frequency
- Set of key tools for machine operation
- Set of leveling pads, screws, and nuts
- Rotary joint for internal cooling through the spindle center
- LED work light
- Support bearing for the table
- Rotary table measuring 600 x 600 mm with evenly distributed weight capacity of 500 kg
- Manual auxiliary control panel (handwheel) with jog and crank functions for X, Y, Z, B, and C axes
- Electrical panel with centrifugal air conditioning and positive pressure
- Single main door with electric safety lock
- B-axis and C-axis rotation at 25 rpm (with table unloaded)
- Spindle housing cooling system (15,000 rpm version)
- Centralized lubrication system with line filter and oil level sensor for guides and ball screws
- External cutting coolant system for the headstock (via eyelet) with exclusive 5 bar pump
- Pneumatic system for spindle taper cleaning and tool unclamping
- Complete hydraulic and pneumatic systems
- Removable 480-liter coolant tank for incorporating an external chip conveyor
- Machine hours counter
- Automatic tool changer (ATC) with 30-tool magazine BT/BBT40 or DIN40
- Standard paint: textured epoxy enamel in Munsell blue 10B-3/4 and textured epoxy paint in RAL 7035 gray.

## Optional equipment\*

- Longitudinal chip conveyor with articulated metal belt (TCE) (A)
- Longitudinal chip conveyor with drag chain (TCA) (A)
- Longitudinal chip conveyor with filter (TCL) (A)
- Air conditioning for electrical panel
- Autotransformer for 200 to 250VAC / 50-60Hz or 360 to 480VAC / 50-60Hz power supply
- Spindle cooling system through the center with high-pressure pump (7 bar or 15 bar) (B)
- Spindle cooling system through the center with external unit and high-pressure pump (20 bar or 70 bar) (B)
- Blade filter for 20-bar high-pressure external unit (F)
- Automatic machine shutdown after shift end (auto power off)
- Calibration sphere (D)
- Upper enclosure for machining area - fixed (C)
- Upper enclosure for machining area - movable (C)
- Smoke filter (E)
- Right side automatic door
- Electro-electronic interface (10,000 rpm version)
- External M-code interface (G)
- Interface for 2-way hydraulic fixture device
- Special paint
- Oil/coolant separator (Oil Skimmer)
- Tool breakage detection system - laser (H)
- Mist exhaust system (B)
- Part measurement/inspection system with probe
- Laser tool presetting system (\*)
- Mechanical tool presetting system (base or table-mounted option)
- Pneumatic cleaning system during machining
- Linear transducer for X/Y/Z axes position (optical scale)
- Status indicator lamp (3 colors)
- Spindle housing cooling system (10,000 rpm version)
- Automatic tool changer (ATC) with robotic arm + 30-tool magazine CAT-40, as replacement for standard
- Workspace cleaning system with 5 bar pump
- Individual washing gun with pump (wash gun) (G)
- Magnetic filter for coolant tank
- Additional set of ROMI product manuals in electronic media
- Additional set of ROMI product manuals in paper format.

### Notes:

- (A) Mandatory optional choice
- (B) Requires the purchase of "Upper enclosure for machining area" - fixed or movable
- (C) The purchase of "Mist exhaust system" is recommended
- (D) Requires the purchase of "Part measurement/inspection system"
- (E) Requires the purchase of "Mist exhaust system"
- (F) Requires the purchase of "Spindle cooling system through the center with external unit and high-pressure pump 20 bar"
- (G) Requires the purchase of "Electro-electronic interface (10,000 rpm version)"

(\*) Contact us for machine layout with optional equipment



**Machine Dimensions** - dimensions in mm\*

**ROMI DCM 620-5F**

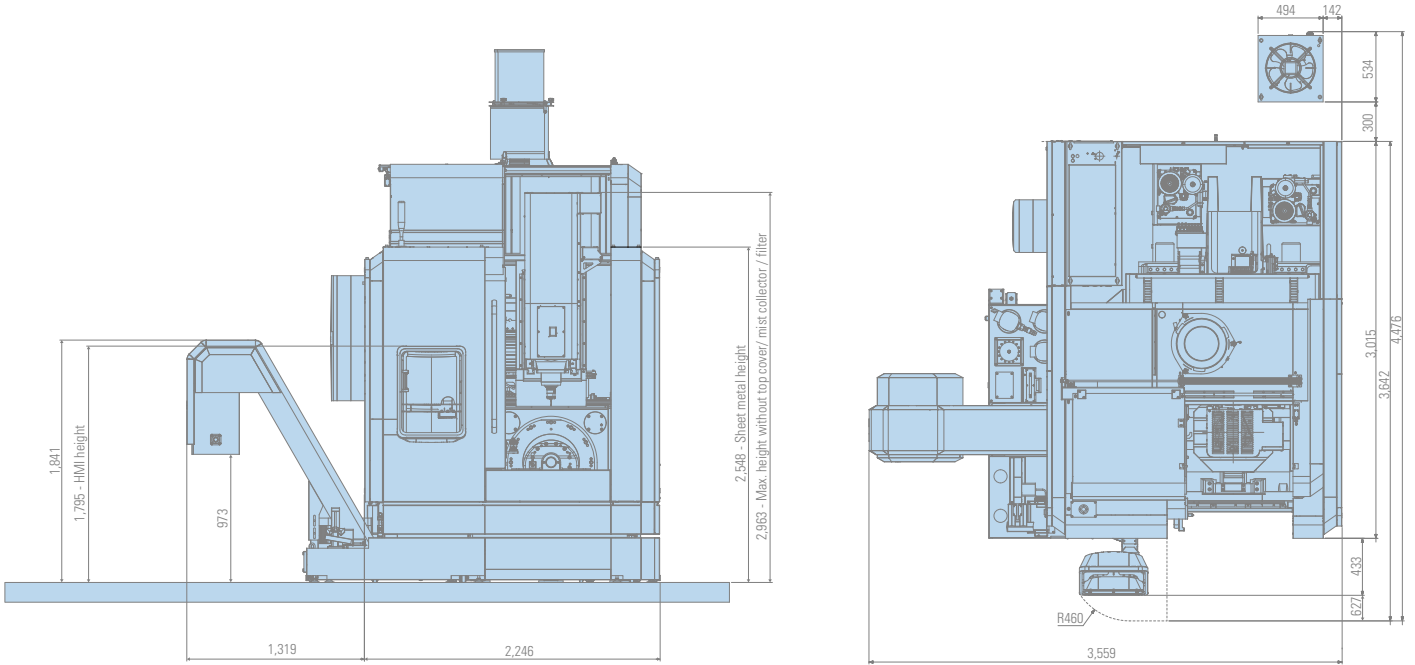

\* Contact us for machine layout with optional features

**Table Dimensions** - dimensions in mm

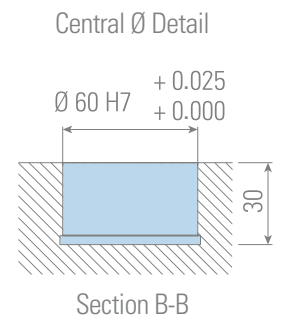
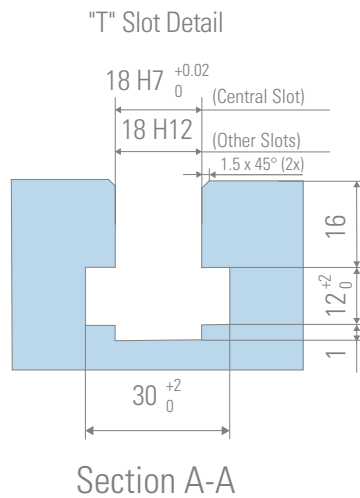
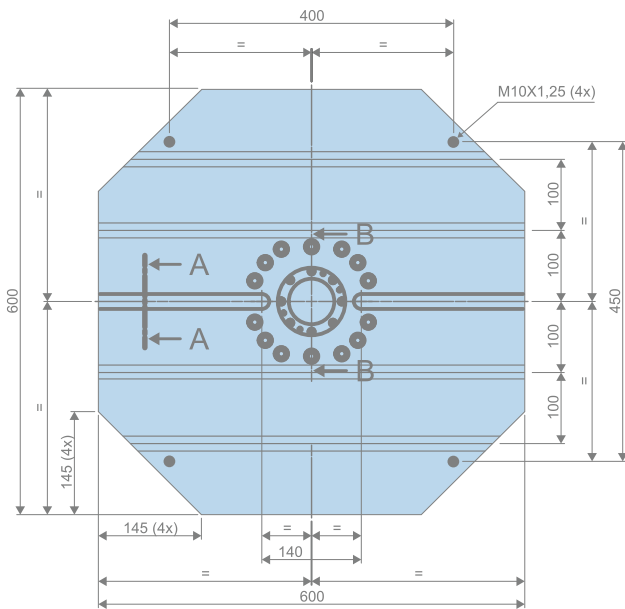





## Work Layout - dimensions in mm

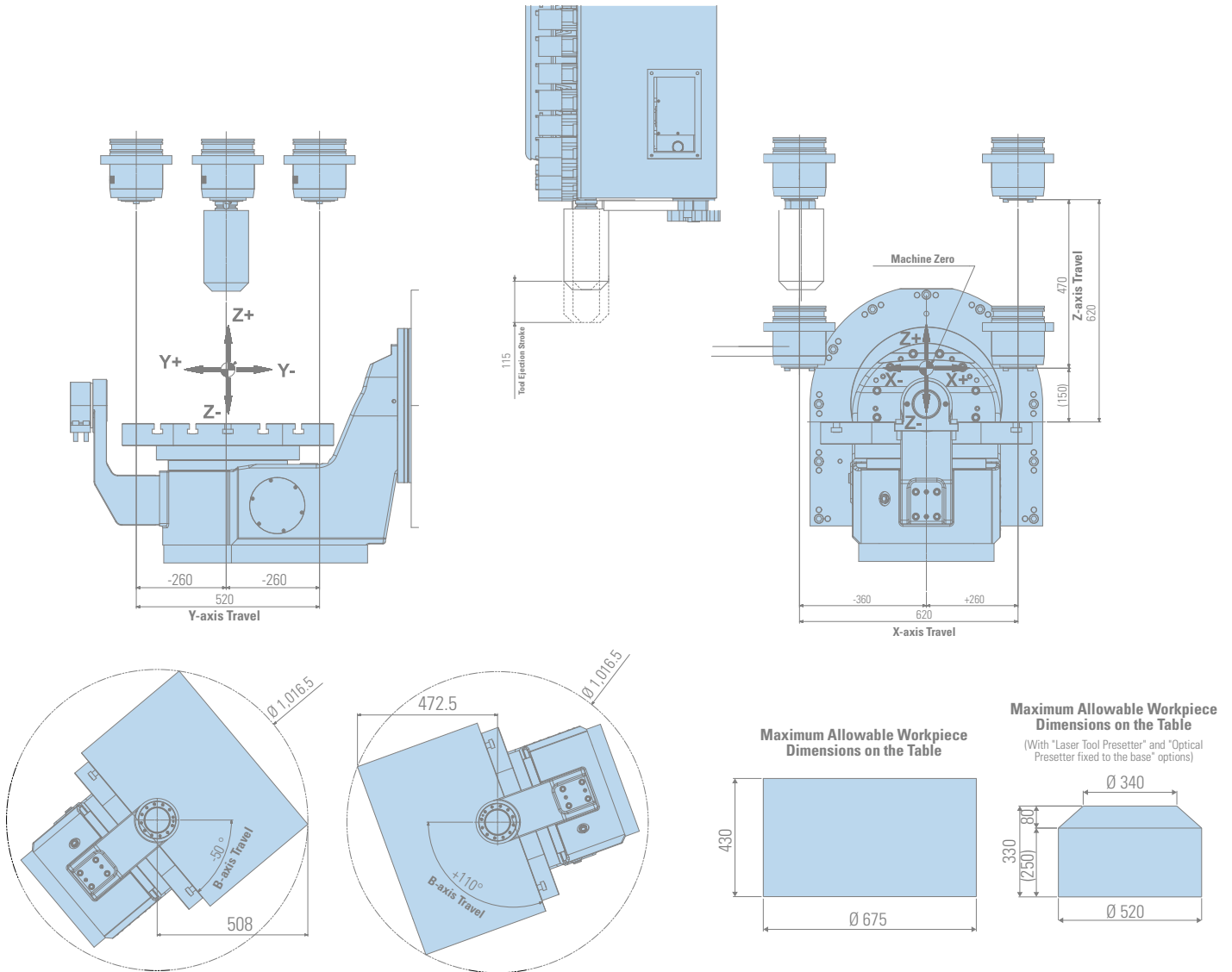

## Power Charts

**ROMI DCM 620-5F  
(10,000 rpm version)**  
S6 Regime - 40% - 10 min

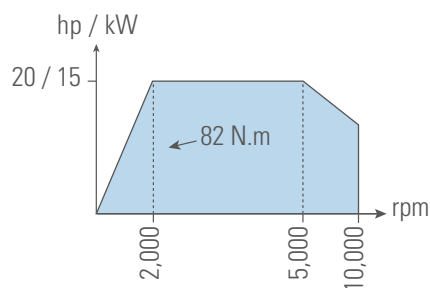

**ROMI DCM 620-5F/ROMI DCM 620-5X  
(15,000 rpm version)**  
S6 Regime - 40% - 10 min

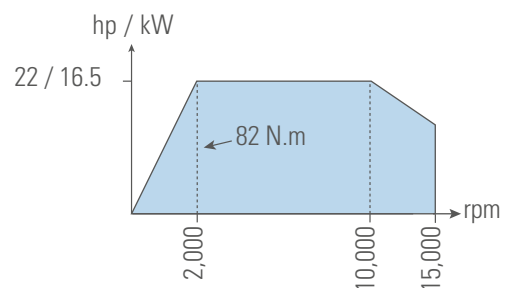

The charts are not to scale.

## CNC Features and Performance

ROMI DCM 620-5F

Siemens 828D

### 1 - CNC Features and Performance:

- 15.6" Monitor
- 80-bit NANO FP Precision
- Advanced Surface for Mold and Die Applications
- Block Processing Time - ~1 ms
- Look Ahead Blocks => 450
- Jerk Control Limited Acceleration
- Segment Error Compensation
- Synchronized Actions and High-Speed Auxiliary Output Function
- Languages: Portuguese, English, Spanish, Italian, German, French
- Ethernet Interface
- USB Interface
- CF Card Interface
- Piece Counter, Machining Cycle Time, and Clock
- Calculator Function
- Automatic Machine Kinematic Measurement
- Sag Compensation
- Automatic Measurement Cycles

### 2 - Programming Features:

- Directory Classified by Programs, Subprograms, and Cycles
- SINUMERIK G Code Programming with High-Level Commands
- Technological Support Cycle for SINUMERIK Programs in G Code
- SHOPMILL Conversational Programming
- High-Speed Settings for Mold and Die Applications
- Subprogram Call
- Program Block Search
- Program Editing During Machining
- Simultaneous Editing of 2 Programs
- Program Memory Quantity = 750
- Program Allocation Memory = 10 MB
- Program Loading and Saving
- Program Creation and Editing
- Linear, Circular, and Helical Interpolation
- Circular Cavity Milling
- Rectangular Cavity Milling
- Milling of Rectangular or Cylindrical Bosses
- Face Milling
- Profile Milling
- Dwell Time

### 3 - Feed Functions:

- Simultaneous Control of 4 Axes (Requires Interpolated Rotary Table)
- Feed in mm/min or in/min
- Feed in mm/rev or in/rev
- Precise Feed and Positioning Control in

Corners

- Exact Stop Mode

### 4 - Graphic Functions:

- Online Graphic Help System
- Machining Graphic Simulation
- 3D Simulation

### 5 - Coordinate Systems:

- Selection of Work Planes
- Work Coordinate System - 100 Pairs Correction
- Machine Coordinate System
- Workpiece Coordinate System Preset
- Local Work Coordinate System

### 6 - Coordinate Values and Dimensions:

- Measurements and Speeds in Inch or Metric
- Absolute and Incremental Mode Programming
- Linear and Circular Interpolation in Polar Coordinates
- Piece Scaling Function
- Block Compression Function "CompCad" and "Advanced Surface"
- Piece Mirroring Function
- Coordinate Plane Rotation
- Coordinate Origin Transfer

### 7 - Spindle Functions:

- Spindle Speed Designation in rpm (S code)
- Angular Positioning of the Spindle Axis

### 8 - Tool-Related Functions:

- Tool Radius Compensation
- Manual Measurement of Tool Length and Radius
- Programmed Automatic Measurement of Tool Length
- Archiving of Measurement Results
- 1024 Pairs of Tool Correctors for Length and Diameter
- Tool Management with Tool Name Reading
- Tool Life Manager

### 9 - Macro:

- Parametric Programming
- User Macros and Variables
- System Variables

### 10 - Program Simplification Functions:

- Cycle 800 - Rotary Tables
- Fixed Drilling, Boring, and Tapping Cycles
- Linear and Circular Hole Patterns
- Hole Grid Pattern
- Straight and Circular Slot Patterns
- Oblong Circular Pattern
- Fixed Tapping Cycle with Rigid Tap
- Fixed Thread Milling Cycle
- Tap with Self-Compensating Tap

- Character Engraving Cycle
- Tap with Rigid Tap
- Highlight in Programming Syntax and Use of Shortcuts (Ctrl+C, Ctrl+V, etc.)
- User Variables (R Parameters) with Comment
- Cylindrical Interpolation (Requires Interpolated Rotary Table)

### 11 - Programming Format - 828D Series

- ISO Programming Format for 828D Control
- SHOPMILL Conversational Programming

### 12 - Execution Operations:

- Jog Mode
- Electronic Handwheel Mode
- MDA Mode
- Automatic Mode
- Block-by-Block Mode
- Program Stop Mode
- Optional Program Stop Mode
- Program Test Operation Mode
- Block Omission Mode ( / )
- Axis Referencing via Program
- Retraction and Tool Repositioning in JOG (REPOS Key)
- Program Execution Restart Mode
- Automatic Program Operation from Memory or Remote

### 13 - Maintenance Functions:

- Alarm and Diagnostics Functions
- Emergency Stop
- Intelligent Maintenance Plan
- Intuitive Alarm/Fault Synoptic

### 14 - Integrated Safety Functions:

- Personal and Machine Safety Functions in the Drive:
  - Safe Torque Off (STO)
  - Safe Brake Control (SBC)
  - Safe Stop 1 (SS1)
- Complementary Safety Functions:
  - Safe Torque Off (STO)
  - Safe Stop 1 (SS1)
  - Safe Stop 2 (SS2)
  - Safe Operation Stop (SOS)
  - Safe Limited Speed (SLS)
  - Safe Acceleration Monitoring (SAM) / Safe Braking Ramp (SBR)
  - Safe Speed Monitoring (SSM)
  - Safe Position Limit (SLP)
  - Safe Direction of Motion (SDI)
- Safe Brake Module (SBM): Safe Brake Control (SBC) and Safe Brake Test (SBT)
- Module for Controlling Complementary Safety Functions (TM54F)





## CNC Features

ROMI DCM 620-5X  
SIEMENS SINUMERIK ONE

### 1 - CNC Resources and Performance

- Monitor 24" Multitouch
- 24" Multitouch Monitor
- 80-bit NANO FP Precision
- Advanced Surface for Mold and Die Applications
- Block Processing Time = ~0.3ms
- Look Ahead Blocks = 1000
- Acceleration with Jerk Control Limitation
- Segment Error Compensation
- Synchronized Actions and High-Speed Auxiliary Output Function
- Languages: Portuguese, English, Spanish, Italian, German, French
- USB Interface
- Ethernet Interface
- Part Counter, Machining Cycle Time, and Clock Calculator Function
- Automatic Machine Kinematic Measurement
- Sag Compensation
- Automatic Measurement Cycles

### 1.1 - 5-Axis Package

- 5-Axis Machining Package
- 5-Axis Simultaneous Interpolation
- Spline Interpolation
- Cylindrical Transformation - TRANSMIT
- 5-Axis Tool Orientation Transformation - TRAORI
- Tool Length Compensation for 5-Axis Machine
- 3D Tool Radius Compensation
- Oriented Tool Retraction
- Remote Tool Center Point Function
- Orientation Change Smoothing - ORISON
- "Advanced Surface" Motion Control
- Top Surface
- Top Speed Plus
- Automatic Machine Kinematics Measurement
- Automatic Measurement Cycles
- 3D Simulation
- Real-Time Simulation
- ShopMill - Step Programming
- Residual Material Detection
- DXF File Reading
- User Memory Expansion
- Execution of Programs from External Storage Devices

### 2 - Programming Resources

- Directory Classified by Programs, Subprograms, and Cycles
- SINUMERIK G-Code Programming with High-Level Commands
- Technological Support Cycle for SINUMERIK Programs in G-Code
- SHOPMILL Conversational Programming
- Built-in ISO Code Interpreter
- High-Speed Settings for Mold and Die Applications
- Sub-Program Calling
- Program Block Search
- Program Editing During Machining
- Simultaneous Program Editing

- Program Quantity in Memory = 1000
- Program Memory Allocation = 10MB
- Program Loading and Saving
- Program Creation and Editing
- Linear, Circular, and Helical Interpolation
- Circular Pocket Milling
- Rectangular Pocket Milling
- Rectangular Boss Milling
- Circular Boss Milling
- Multi-Face Boss Milling
- Face Milling
- Profile Milling
- Dwell Time

### 3 - Feed Functions

- Simultaneous 5-Axis Control
- Feed in mm/min or in/min
- Feed in mm/rev or in/rev
- Precise Feed and Corner Positioning
- Exact Stop Mode

### 4 - Graphic Functions

- Animated Elements - Dynamic Support for Cycles
- Online Graphic Help System
- Graphic Machining Simulation
- 3D Simulation
- Quick Visualization of Molds and Dies

### 5 - Coordinate Systems

- Selection of Work Planes
- Work Coordinate System = 100 Pairs Correction
- Machine Coordinate System
- Local Work Coordinate System
- Piece Coordinate System Preset

### 6 - Coordinate Values and Dimensions

- Measurement and Speed Systems in Inches or Metric
- Absolute and Incremental Programming
- Linear and Circular Interpolation in Polar Coordinates
- Piece Scaling Function
- Block Compression Function "CompCad" and "Advanced Surface"
- Piece Mirroring Function
- Rotation of Coordinate System
- Coordinate System Origin Transfer

### 7 - Spindle Functions

- Spindle Designation in rpm (S code)
- Angular Positioning of the Spindle Axis

### 8 - Funções Aplicadas à Ferramenta

- Tool Radius Compensation
- 1500 Pairs of Tool Length and Diameter Correctors
- Manual Measurement of Tool Length and Radius
- Automatic Measurement of Tool Length and Radius
- Tool Management with Tool Name Reading
- Tool Life Manager
- Load/Unload Function for Simple Magazine Allocation

### 9 - Macro

- Parametric Programming
- User Macros and Variables

- System Variables

### 10 - Program Simplification Functions

- Cycle 800 - Rotary Tables
- Fixed Cycles for Drilling, Boring, and Tapping
- Linear and Circular Hole Patterns
- Hole Grid Pattern
- Circular Straight and Circular Groove Patterns
- Circular Oblong Pattern
- Fixed Cycle for Rigid Tapping
- Fixed Cycle for Auto-Compensating Tapping
- Fixed Cycle for Thread Milling
- Chamfering and Corner Rounding
- Mirror Image Programming
- Cylindrical Interpolation
- Character Engraving Cycle
- Syntax Highlighting and Use of Shortcuts (Ctrl+C, Ctrl+V, etc.)
- User Variables (R parameters) with Comments

### 11 - Programming Format

- SINUMERIK G-Code Programming
- SHOPMILL Conversational Programming
- ISO Programming Format

### 12 - Execution Operations

- JOG Motion Mode
- Electronic Handwheel Mode
- MDA Mode
- Auto Mode
- Block-by-Block Mode
- Program Stop Mode
- Optional Program Stop Mode
- Program Testing Operations Mode
- Block Omission Mode ( / )
- Axis Referencing via Program
- Retraction and Tool Repositioning in JOG (REPOS key)
- Program Execution Restart Mode
- Automatic Program Operation from Memory or Remote

### 13 - Maintenance Functions

- Alarm and Diagnostic Functions
- Emergency Stop
- Intelligent Maintenance Plan
- Intuitive Alarm/Fault Synoptic
- Trace-Based Diagnostics: CNC, PLC, and Drives

### 14 - Integrated Safety Functions

- Safe Torque Off (STO)
- Safe Brake Control (SBC)
- Safe Stop 1 (SS1)
- Safe Stop 2 (SS2)
- Safe Operation Stop (SOS)
- Safe Limited Speed (SLS)
- Safe Speed Monitoring (SSM)
- Safe Acceleration Monitoring (SAM)
- Safe Braking Ramp (SBR)
- Safe Limit Position (SLP)
- Safety Cameras (SCA)
- Safe Motion Direction (SDI)
- Safe Brake Test (SBT)
- Integrated Safety in PLC (F-PLC)

### 15 - Energy Control System

- Control Energy - Efficient Machine Operation



# WORLDWIDE PRESENCE

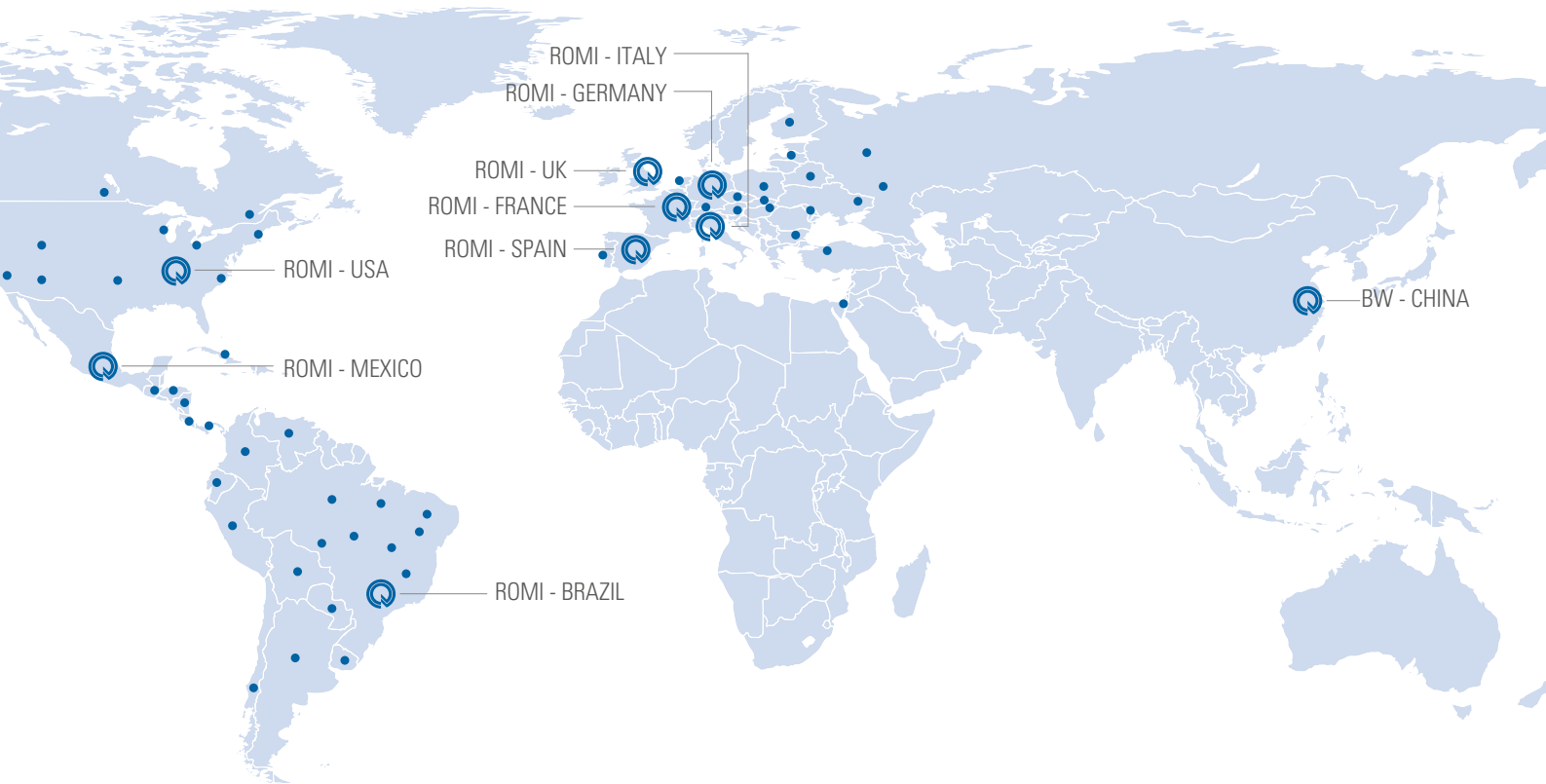

Brazil



United States



Germany



England



France

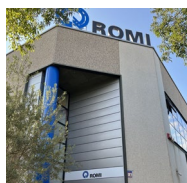

Spain



Italy



Mexico

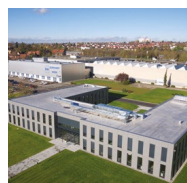

Germany - BW



China - B+W



# ROMI

WWW.ROMI.COM

## ROMI S.A.

Rod. SP 304, Km 141,5  
Santa Bárbara d'Oeste SP  
13459 057 Brazil  
+55 (19) 3455 9000

## Latin America

+55 (19) 3455 9642  
export-mf@romi.com

## Burkhardt+Weber Shanghai

+86 21 6100-5568  
info@cn.burkhardt-weber.net

## Burkhardt+Weber

**Fertigungssysteme GmbH**  
Burkhardt+Weber-Strasse 57  
72760 Reutlingen, Germany  
+49 7121 315-0  
info@burkhardt-weber.de  
www.burkhardt-weber.de

## ROMI BW Machine Tools Ltd

1845 Airport Exchange Blvd  
Erlanger KY – 41018 USA  
+1 (859) 647 7566  
sales@romiusa.com  
www.romiusa.com

## ROMI Europa GmbH

Burkhardt+Weber-Strasse 57  
72760 Reutlingen, Germany  
+49 7121 315-604  
sales@romi-europa.de  
www.romi-europa.de

## ROMI France SAS

Parc de Genève, 240  
Rue Ferdinand Perrier 69800  
ST Priest  
+33 4 37 25 60 70  
infos@romifrance.fr  
www.romifrance.fr

## ROMI Machines UK Limited

Leigh Road  
Swift Valley Industrial Estate  
Rugby CV21 1DS  
+44 1788 544221  
sales@romiuk.com  
www.romiuk.com

## ROMI Maquinas España

C/ Telemática, 9 - Poligono  
Industrial La Ferreria - 08110  
Montcada I Reixac - Barcelona  
+34 93 719 4926  
info@romi.es  
www.romi.es

## ROMI en México

Condominio Parque Arista, Calle  
Gral. Mariano Arista 54, bodega 19  
Col. Argentina Poniente, Miguel Hidalgo  
C.O. 11230, CDMX, México  
+521 55 9154 5851  
ventasmx@romi.com  
www.romimexico.com

## ROMI Itália Srl

Via Morigi, 33 – 29020  
Gossolengo (PC) – Italy  
+39 0523 778 956  
commerciale@romiitalia.it  
www.romiitalia.it



ISO 9001:2015  
Certificate No. 31120



ISO 14001:2015  
Certificate No. 70671



CE safety regulation compliance available only for the European Community or under request.  
Check availability and technical characteristics of the products to your country.

